

- Please check your product packaging to make sure the included accessories are in the "list of standard accessories." If any parts are missing, please contact your local dealer immediately.
- Do not allow any sharp objects to come in contact with the cabinet, as it will scratch the surface.
- Continuous and prolonged exposure to direct sunlight may cause discoloration to the wood.
- Do not put any hot appliances directly on or near the cabinet.
- Please avoid using cleaning products that contain bleach or ammonia.
- The surfaces should only be cleaned with the care products such as soapy water or furniture polish.

Main Body Parts

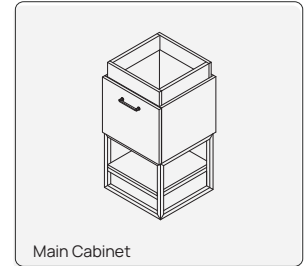

Installation Parts

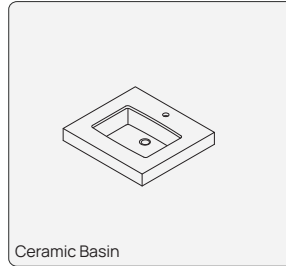
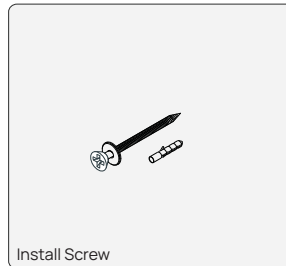

Installation

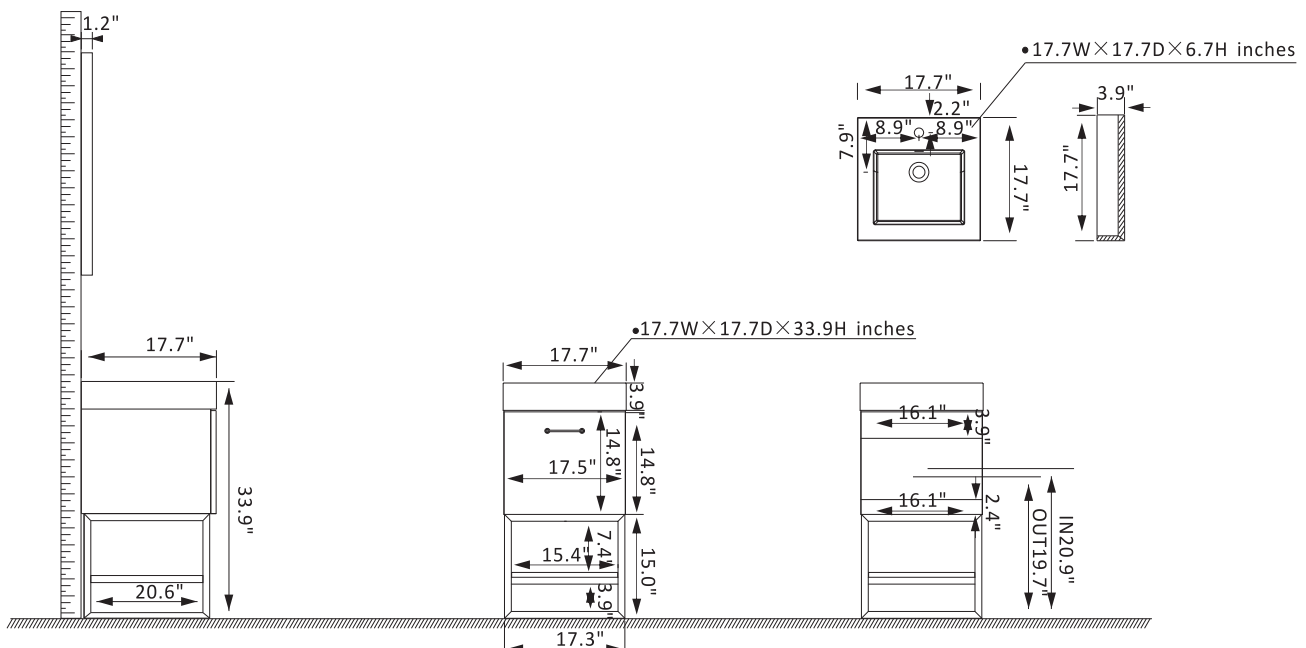

Tools Needed



Install, Remove, Adjust of Top Fast Loading Hinge

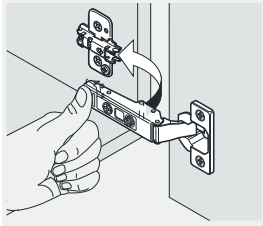

Install

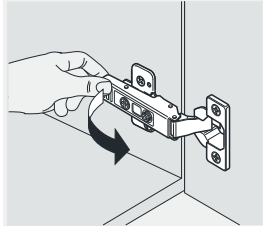

Remove

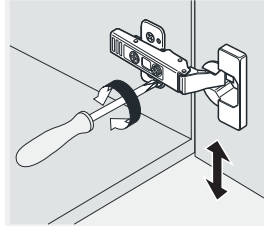

Adjust the Height

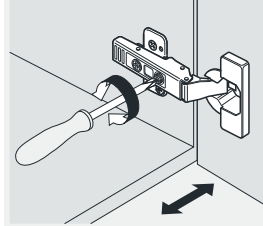

Adjust the Lateral

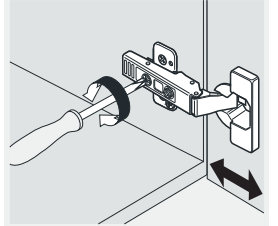

Adjust the Depth

Drawer Adjust

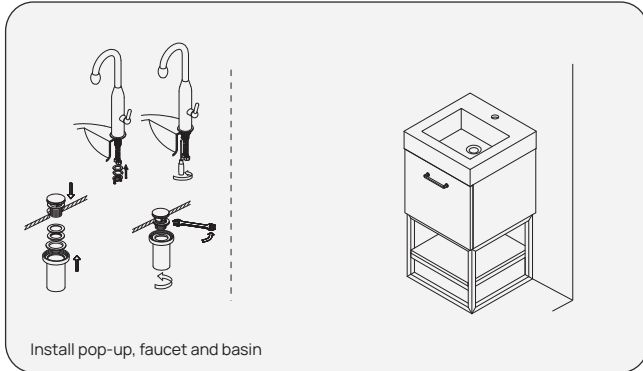

Install pop-up, faucet and basin